



G168-0001

ULTRA SLIMPAK® G168-0001

DC Powered AC Input Limit Alarm

Provides Relay Contact Closures
at a Preset AC Input Level



- Programmable HI or LO, Failsafe or Non-failsafe
- Field Configurable Input Ranges
- LED Trip and Input Indicators
- Flexible Power Supply Accepts 9 to 30 VDC
- ASIC Technology for Enhanced Reliability
- RoHS Compliant

Description

The Ultra Slim Pak G168 is a DIN rail mount, DC powered, AC voltage or current input limit alarm with dual setpoints and two contact closure outputs. The field configurable input and alarm functions offer flexible setpoint capability. Input voltage spans from 100mV to 250VAC and input current spans from 10mA to 100mA AC can be field configured. For current input spans of 1 to 5 Amps a 0.1 Ohm (5W) shunt resistor (Model# C006) is available.

The G168 is configurable as a single or dual setpoint alarm, with HI or LO trips and failsafe or non-failsafe operation. Also included are adjustable deadbands (0.25 to 5% of full scale input) for each setpoint. The G168 will accept any DC voltage between 9 and 30VDC.

Diagnostic LEDs

The G168 is equipped with three front panel LEDs. The dual function green LED is labeled INPUT and indicates line power and input signal status. Active DC power is indicated by an illuminated LED. If this LED is off, check DC power and the wiring connection. If the input signal is more than 110% of the full scale range, the LED will flash at 8 Hz. Below 0%, it flashes at 4 Hz. Two red LEDs indicate the relay state for each setpoint. An illuminated red LED indicates the tripped condition.

Output

The G168 is equipped with two SPDT (form C) relays, rated at 120VAC or 28VDC at 5 Amperes. Each of these relays is independently controlled by the field configurable setpoint and deadband.

Operation

The field configurable G168 limit alarm setpoints can be configured for HI or LO, failsafe or non-failsafe operation. Each of the setpoints have a respective HI or LO deadband. In a tripped condition, the setpoint is exceeded and the appropriate red LED will illuminate. The trip will reset only when the process falls below the HI deadband or rises above the LO deadband (see Figure 1). For proper deadband operation, the HI setpoint must always be set above the LO setpoint. In failsafe operation, the relay is energized when the process is below the HI setpoint or above the LO setpoint (opposite for non-failsafe). In the failsafe mode, a power failure results in an alarm state output.

Dynamic Deadband

Circuitry in the G168 prevents false trips by repeatedly sampling the input. The input must remain beyond the setpoint for 100 milliseconds, uninterrupted, to qualify as a valid trip condition. Likewise, the input must fall outside the deadband and remain there for 100 milliseconds to return the alarm to an untripped condition. This results in a “dynamic deadband” (based on time) in addition to the normal deadband.

Configuration

Unless otherwise specified, the factory presets the Model G168 as follows:

- Input: Voltage
- Range: 0-500mVAC
- Output: Dual, SPDT
- Trip: A:HI, B:LO
- Failsafe: No
- Deadband: A, B: 0.25%

The DC power input accepts any DC source between 9 and 30V; typically a 12V or 24VDC source is used (see Accessories).

For other I/O ranges, refer to Table 1 and Figure 4 to reconfigure switches SW1 and SW2 for the desired input type, range and function.

1. With DC power off, position input switch "SW1-9, 10" for voltage or current.
2. Set position 1 through 8 of "SW1" for the desired input range (see Table 1).
3. Set position 1 and 2 of "SW2" to ON for a HI trip setpoint or OFF for a LO trip (see Figure 4).
4. Set position 4 of "SW2" to ON for non-failsafe operation or OFF for failsafe operation (e.g., alarm trips when power fails).

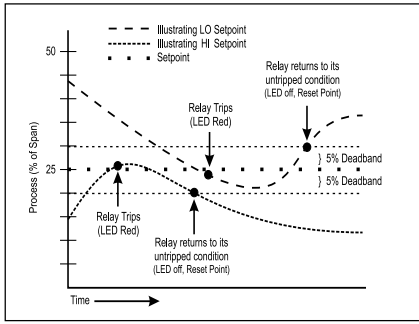

Figure 1: Limit alarm operation and effect of deadband.

Calibration

Note: To maximize thermal stability, final calibration should be performed in the operation installation, allowing approximately 1 to 2 hours for warm up and thermal equilibrium of the system.

1. After configuring the dip switches, connect the input to a calibrated AC source and apply power. Refer to the terminal wiring (Figure 6).
2. Setpoint: set deadband at its minimum (fully counterclockwise) before adjusting the setpoint. With the desired trip input applied, adjust the setpoint until the relay trips. For HI trip calibration, start with the setpoint above the desired trip (fully clockwise). For LO trip calibration, start below the desired trip (fully counterclockwise).
3. Deadband: Set deadband to its minimum (fully counterclockwise). Set the setpoint to the desired trip. Adjust the input until the relay trips. Readjust deadband to 5% (fully clockwise). Set the input signal to the desired deadband position. Slowly adjust deadband until the relay untrips

Relay Protection & EMI Suppression

When switching inductive loads, maximum relay life and transient EMI suppression is achieved using external protection (see Figures 2 and 3). Place all protection devices directly across the load and minimize all lead lengths. For AC inductive loads, place a properly rated MOV across the load in parallel with a series RC snubber. Use a 0.01 to 0.1uF pulse film capacitor (foil polypropylene recommended) of sufficient voltage, and a 47 ohm, 1/2W carbon resistor. For DC inductive loads, place a diode across the load (PRV > DC supply, 1N4006 recommended) with (+) to cathode and (-) to anode (the RC snubber is an optional enhancement).

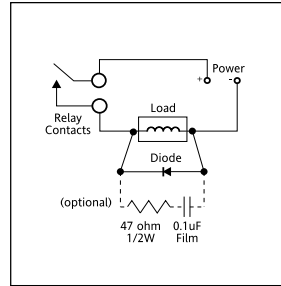

Figure 2: DC Inductive Loads

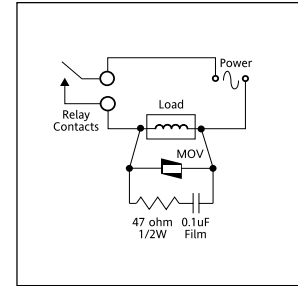

Figure 3: AC Inductive Loads

Table 1: G168 Input Range Settings

Ranges		Selector SW1									
Voltage	Current	1	2	3	4	5	6	7	8	9	10
100mV	10mA				■					■	
200mV	20mA				■		■		■		
500mV	50mA			■			■		■		
1V	100mA			■	■					■	
2V				■	■			■	■		
5V		■		■	■		■	■			
10V		■	■	■	■						
20V		■	■	■	■						
50V			■	■	■	■					
100V			■	■	■	■					
200V			■	■	■	■					
250V			■	■	■	■					
Input Type											
Current											■
Voltage										■	

Key: ■ = 1 = ON or Closed

Table 2: G168 Trip Settings

Function	Selector SW2			
	1	2	3	4
Trip B HI	■			
Trip A HI		■		
Non-Failsafe				■

Key: ■ = 1 = ON or Closed

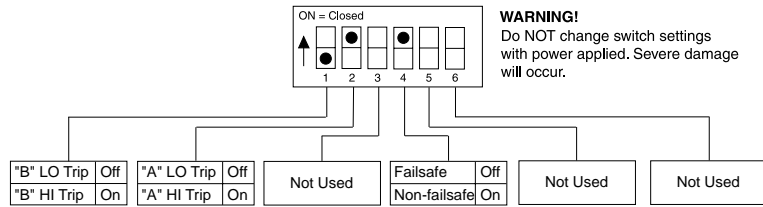

Figure 4: G168 Function Selection Switch-Settings (SW4) Factory Default Settings

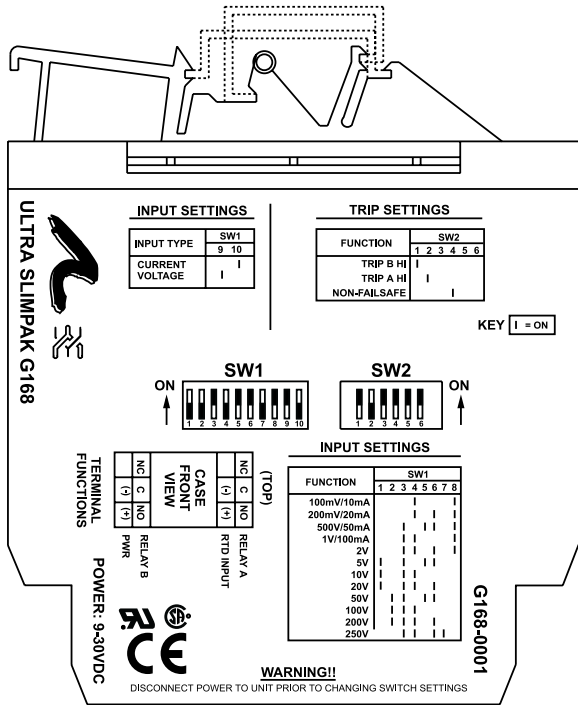

Figure 5: G168 Factory Calibration; 0-500mV, A-HI/B-LO, Non-Failsafe

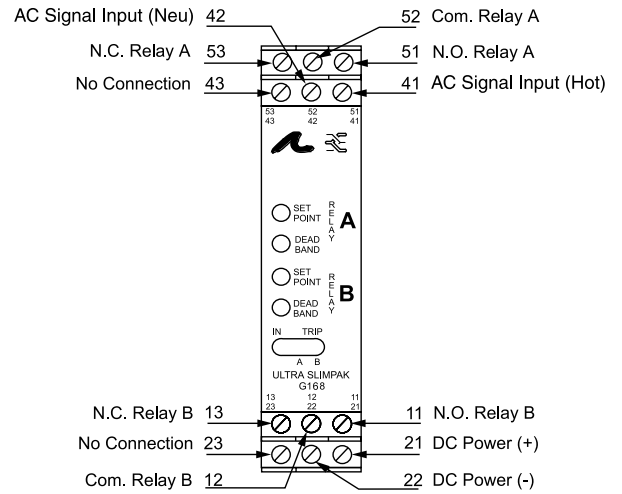

Figure 6: G168 Wiring Diagram

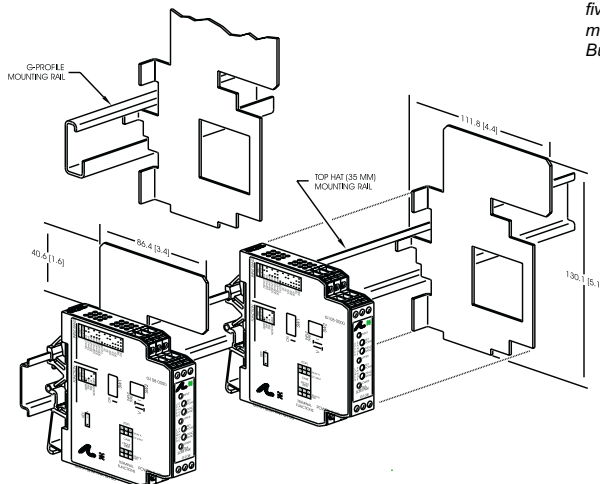

Figure 7: Mounting Multiple Modules

Note: All Ultra SlimPak modules are designed to operate in ambient temperatures from 0 to 55°C when mounted on a horizontal DIN rail. If five or more modules are mounted on a vertical rail, circulating air or model HS01 Heat Sink is recommended. Refer to HS01 Technical Bulletin (#721-0549-00) or contact the factory for assistance.

Specifications

Inputs

Voltage Input

Range: 100mV to 250VAC
Impedance: >100K Ohms
Overvoltage: 300VAC, max.

Current Input

Range: 10mA to 100mA AC
Impedance: 20 Ohms, typical
Overcurrent: 200mA AC, max.
Overvoltage: 60V peak (protected by self resetting fuse)
Frequency Range: 40 to 400Hz
Common Mode (Input to Gnd): 1800VDC, max.

LED Indicators

Input Range (Green)

>110% input: 8Hz flash

Setpoint (Red)

Tripped: Solid red
Safe: Off

Limit Differentials (Deadbands)

>50mV/5mA: 0.25% to 5% of span
<50mV/5mA: 1% to 5% of span

Response Time

Dynamic Deadband:

Relay status will change when proper setpoint/process condition exists for 100msec.

Normal Mode (analog filtering):

<250mSec, (10-90%)

Setpoints

Effectivity:

Setpoints are adjustable over 100% of the selected input span

Repeatability (constant temp.):

0.2% of full scale

Stability

Temperature: $\pm 0.025\%$ of full scale/ $^{\circ}\text{C}$, max.

Common Mode Rejection

DC to 60Hz: 120dB

Isolation

1800VDC between contacts, input & power

EMC Compliance (CE Mark)

Emmissions: EN50081-1

Immunity: EN50082-1

Safety: EN50178

Humidity (Non-Condensing)

Operating: 15 to 95% @45 $^{\circ}\text{C}$

Soak: 90% for 24hours @65 $^{\circ}\text{C}$

Temperature Range

Operating: 0 to 55 $^{\circ}\text{C}$ (32 to 131 $^{\circ}\text{F}$)

Storage: -25 to 70 $^{\circ}\text{C}$ (-13 to 158 $^{\circ}\text{F}$)

Power

Consumption: 1.5W typical, 2.5W max.

Supply Range: 9 to 30VDC, inverter isolated

Relay Contacts

2 SPDT (2 form C) Relays, 1 Relay per setpoint

Current Rating (resistive):

120VAC: 5A; 240VAC: 2A; 28VDC: 5A

Material: Gold flash over silver alloy

Electrical Life: 10⁵ operations at rated load

Note: External relay contact protection is required for use with inductive loads (see Figures 2 & 3).

Mechanical Life: 10⁷ operations

Wire Terminations

Screw terminals for 12-22 AWG

Agency Approvals

UL recognized per standard UL508

(File No.E99775)

CE Conformance per EMC directive 89/336/EEC & Low Voltage 73/23/EEC (Input <50VAC, only).

RoHS Compliant

Ordering Information

Models & Accessories

Specify:

1. Model: **G168-0001**
2. Accessories: (see Accessories)
3. Optional Custom Factory Calibration; specify **C620** with desired input and output range.

Accessories

SlimPak "G" series modules will mount on standard TS32 (model MD02) or TS35 (model MD03) DIN. In addition, the following accessories are available:

HS01	Heat Sink
MD03	TS35 x 7.5 DIN Rail
WV905	24VDC Power Supply (0.5Amp)
H910	24VDC Power Supply (1Amp)
H915	24VDC Power Supply (2.3 Amp)
MB03	End Bracket for MD03
C664	I/O Descriptive Tags
C006	Shunt Resistor (0.1W, 5A max.)

Dimensions

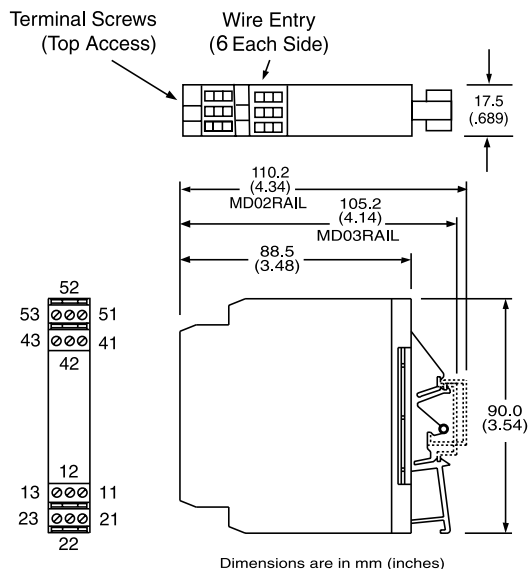

Factory Assistance

For additional information on calibration, operation and installation contact our Technical Services Group:

703-669-1318

actionsupport@eurotherm.com

721-0667-00-F 02/09 Copyright© Eurotherm, Inc 2009

Eurotherm, Inc

741-F Miller Drive
Leesburg, VA 20175-8993
703-443-0000

info@eurotherm.com or www.eurotherm.com/actionio

Action Instruments

Barber-Colman

Chessell

Continental

Eurotherm